

BOXER-8251AI

Compact Fanless Embedded AI@Edge Box PC
with NVIDIA[®] Jetson Xavier[™] NX
User's Manual 1st Ed

Copyright Notice

This document is copyrighted, 2021. All rights are reserved. The original manufacturer reserves the right to make improvements to the products described in this manual at any time without notice.

No part of this manual may be reproduced, copied, translated, or transmitted in any form or by any means without the prior written permission of the original manufacturer. Information provided in this manual is intended to be accurate and reliable. However, the original manufacturer assumes no responsibility for its use, or for any infringements upon the rights of third parties that may result from its use.

The material in this document is for product information only and is subject to change without notice. While reasonable efforts have been made in the preparation of this document to assure its accuracy, AAEMON assumes no liabilities resulting from errors or omissions in this document, or from the use of the information contained herein.

AAEMON reserves the right to make changes in the product design without notice to its users.

Acknowledgements

All other products' name or trademarks are properties of their respective owners.

- NVIDIA®, the NVIDIA logo, Jetson™ and Jetson Xavier™ are trademarks of the NVIDIA Corporation
- ITE is a trademark of Integrated Technology Express, Inc.
- IBM and VGA are trademarks of International Business Machines Corporation.
- Ubuntu is a registered trademark of Canonical

All other product names or trademarks are properties of their respective owners. No ownership is implied or assumed for products, names or trademarks not herein listed by the publisher of this document.

Packing List

Before setting up your product, please make sure the following items have been shipped:

Item	Quantity
● BOXER-8251AI	1
● Power Connector	1

If any of these items are missing or damaged, please contact your distributor or sales representative immediately.

About this Document

This User's Manual contains all the essential information, such as detailed descriptions and explanations on the product's hardware and software features (if any), its specifications, dimensions, jumper/connector settings/definitions, and driver installation instructions (if any), to facilitate users in setting up their product.

Users may refer to the product page at AAEON.com for the latest version of this document.

Safety Precautions

Please read the following safety instructions carefully. It is advised that you keep this manual for future references

1. All cautions and warnings on the device should be noted.
2. All cables and adapters supplied by AAEON are certified and in accordance with the material safety laws and regulations of the country of sale. Do not use any cables or adapters not supplied by AAEON to prevent system malfunction or fires.
3. Make sure the power source matches the power rating of the device.
4. Position the power cord so that people cannot step on it. Do not place anything over the power cord.
5. Always completely disconnect the power before working on the system's hardware.
6. No connections should be made when the system is powered as a sudden rush of power may damage sensitive electronic components.
7. If the device is not to be used for a long time, disconnect it from the power supply to avoid damage by transient over-voltage.
8. Always disconnect this device from any AC supply before cleaning.
9. While cleaning, use a damp cloth instead of liquid or spray detergents.
10. Make sure the device is installed near a power outlet and is easily accessible.
11. Keep this device away from humidity.
12. Place the device on a solid surface during installation to prevent falls
13. Do not cover the openings on the device to ensure optimal heat dissipation.
14. Watch out for high temperatures when the system is running.
15. Do not touch the heat sink or heat spreader when the system is running
16. Never pour any liquid into the openings. This could cause fire or electric shock.

17. As most electronic components are sensitive to static electrical charge, be sure to ground yourself to prevent static charge when installing the internal components. Use a grounding wrist strap and contain all electronic components in any static-shielded containers.
18. If any of the following situations arises, please the contact our service personnel:
 - i. Damaged power cord or plug
 - ii. Liquid intrusion to the device
 - iii. Exposure to moisture
 - iv. Device is not working as expected or in a manner as described in this manual
 - v. The device is dropped or damaged
 - vi. Any obvious signs of damage displayed on the device
19. **DO NOT LEAVE THIS DEVICE IN AN UNCONTROLLED ENVIRONMENT WITH TEMPERATURES BEYOND THE DEVICE'S PERMITTED STORAGE TEMPERATURES (SEE CHAPTER 1) TO PREVENT DAMAGE.**

FCC Statement

Warning!



This device complies with Part 15 FCC Rules. Operation is subject to the following two conditions: (1) this device may not cause harmful interference, and (2) this device must accept any interference received including interference that may cause undesired operation.

Caution:

There is a danger of explosion if the battery is incorrectly replaced. Replace only with the same or equivalent type recommended by the manufacturer. Dispose of used batteries according to the manufacturer's instructions and your local government's recycling or disposal directives.

Attention:

Il y a un risque d'explosion si la batterie est remplacée de façon incorrecte. Ne la remplacer qu'avec le même modèle ou équivalent recommandé par le constructeur. Recycler les batteries usées en accord avec les instructions du fabricant et les directives gouvernementales de recyclage.

产品中有毒有害物质或元素名称及含量

AAEON System

QO4-381 Rev.A0

部件名称	有毒有害物质或元素					
	铅 (Pb)	汞 (Hg)	镉 (Cd)	六价铬 (Cr(VI))	多溴联苯 (PBB)	多溴二苯 醚(PBDE)
印刷电路板 及其电子组件	×	○	○	○	○	○
外部信号 连接器及线材	×	○	○	○	○	○
外壳	○	○	○	○	○	○
中央处理器 与内存	×	○	○	○	○	○
硬盘	×	○	○	○	○	○
液晶模块	×	×	○	○	○	○
光驱	×	○	○	○	○	○
触控模块	×	○	○	○	○	○
电源	×	○	○	○	○	○
电池	×	○	○	○	○	○

本表格依据 SJ/T 11364 的规定编制。

○：表示该有毒有害物质在该部件所有均质材料中的含量均在 GB/T 26572 标准规定的限量要求以下。

×：表示该有害物质的某一均质材料超出了 GB/T 26572 的限量要求，然而该部件仍符合欧盟指令 2011/65/EU 的规范。

备注：

- 一、此产品所标示之环保使用期限，系指在一般正常使用状况下。
- 二、上述部件物质中央处理器、内存、硬盘、光驱、电源为选购品。
- 三、上述部件物质液晶模块、触控模块仅一体机产品适用。

Hazardous and Toxic Materials List

AAEON System

QO4-381 Rev.A0

Component Name	Hazardous or Toxic Materials or Elements					
	Lead (Pb)	Mercury (Hg)	Cadmium (Cd)	Hexavalent Chromium (Cr(VI))	Polybrominated biphenyls (PBBS)	Polybrominated diphenyl ethers (PBDES)
PCB and Components	X	O	O	O	O	O
Wires & Connectors for Ext.Connections	X	O	O	O	O	O
Chassis	O	O	O	O	O	O
CPU & RAM	X	O	O	O	O	O
HDD Drive	X	O	O	O	O	O
LCD Module	X	X	O	O	O	O
Optical Drive	X	O	O	O	O	O
Touch Control Module	X	O	O	O	O	O
PSU	X	O	O	O	O	O
Battery	X	O	O	O	O	O

This form is prepared in compliance with the provisions of SJ/T 11364.
 O: The level of toxic or hazardous materials present in this component and its parts is below the limit specified by GB/T 26572.
 X: The level of toxic of hazardous materials present in the component exceed the limits specified by GB/T 26572, but is still in compliance with EU Directive 2011/65/EU (RoHS 2).

Notes:

1. The Environment Friendly Use Period indicated by labelling on this product is applicable only to use under normal conditions.
2. Individual components including the CPU, RAM/memory, HDD, optical drive, and PSU are optional.
3. LCD Module and Touch Control Module only applies to certain products which feature these components.

Table of Contents

Chapter 1 - Product Specifications	1
1.1 Specifications	2
1.2 Product Notice	4
Chapter 2 – Hardware Information	5
2.1 Dimensions	6
2.2 Jumpers and connectors.....	7
2.3 List of Jumpers	9
2.3.1 Setting Jumpers	9
2.3.2 AT/ATX Mode Select (CN1 Pins 7-8)	10
2.4 List of Connectors.....	11
2.4.1 Front Panel Connector (CN1)	12
2.4.2 DC Power In Connector (CN2)	12
2.4.3 USB 2.0 Connector for Flash Image (CN3)	13
2.4.4 LAN RJ45 Port (CN4).....	13
2.4.5 HDMI Connector (CN5)	14
2.4.6 Dual USB 3.2 Gen 1 Connector (CN6/CN7)	15
2.4.7 RTC Battery Connector (CN8).....	15
2.4.8 COM Port Connector (CN9/CN10)	16
2.4.9 COM Port Connector (System).....	16
2.4.10 Jetson Xavier CPU Module Connector (CN12)	18
2.4.11 UART Debug Port Connector (CN15).....	20
2.5 Hardware Assembly	21
Chapter 3 – OS Flash Guide	23
3.1 Before Installation.....	24
3.2 Force USB Recovery Mode.....	25
3.2 Flash Image to Board.....	27

This page intentionally left blank.

Chapter 1

Product Specifications

1.1 Specifications

System

CPU	Six Core ARM® Carmel® V8.2 Processor
Chipset	—
System Memory	8GB LPDDR4
AI Solution	Nvidia Jetson Xavier NX
Display Interface	HDMI 2.0
Storage Device	16GB eMMC Micro SD Slot x1
Ethernet	10/100/1000Base-TX x 1 USB 3.2 Gen 1 x 4
I/O	LAN x 1 RS-232 x 2 HDMI x 1 MicroSD x 1 DC Power Input x 1 Recovery Button x 1 Micro-USB for Flash OS x 1
Expansion	M.2 E-Key 2230 x 1(for Wi-Fi)
Indicator	Power LED x 1
OS Support	Linux (AAEON ACLinux 4.9, Compliance with Ubuntu 18.04)

Power Supply

Power Requirement	12Vdc w/ 2-pin terminal block
-------------------	-------------------------------

Mechanical

Mounting	Wallmount
Dimensions (W x D x H)	3.46" x 2.95" x 1.53" (88mm x 75mm x 39mm)
Gross Weight	1.10 lbs. (0.5 kg)
Net Weight	0.66 lbs. (0.3 kg)

Environmental

Storage Temperature	-40°F ~158°F (-40°C ~ 70°C)
Storage Humidity	95% @ 40°C, non-condensing
Anti-Vibration	3 Grms/ 5 ~ 500Hz/ operation – MicroSD or eMMC
Certification	CE/FCC class A

Operating temperature for the BOXER-8251AI is dependent system configuration for Power Mode and Active CPU Cores. The table below details maximum operating temperature without throttling for the system based on available configurations. Table is based on 100% CPU load, 100% GPU load, no throttling, and airflow of 0.5 m/sec.

Operating Temperature

Power Mode	CPU Cores	CPU Maximum Frequency	Operating Temperature
15W	6 Cores	1.4 GHz	-20°C ~ 40°C
	4 Cores	1.4 GHz	-20°C ~ 40°C
	2 Cores	1.9 GHz	-20°C ~ 50°C
10W	4 Cores	1.2 GHz	-20°C ~ 50°C
	2 Cores	1.5 GHz	-20°C ~ 50°C

1.2 Product Notice

Micro-USB: Micro-USB port is ideally for flashing image only.

USB ports: USB ports do not support USB DVD ROM because of file system.

USB 3.2 Gen 1: USB 3.2 Gen 1 is the current name for 5Gbps specification, formerly USB 3.0.

LAN Indicator Behavior

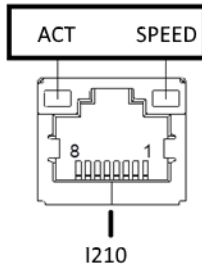

Chapter 2

Hardware Information

2.1 Dimensions

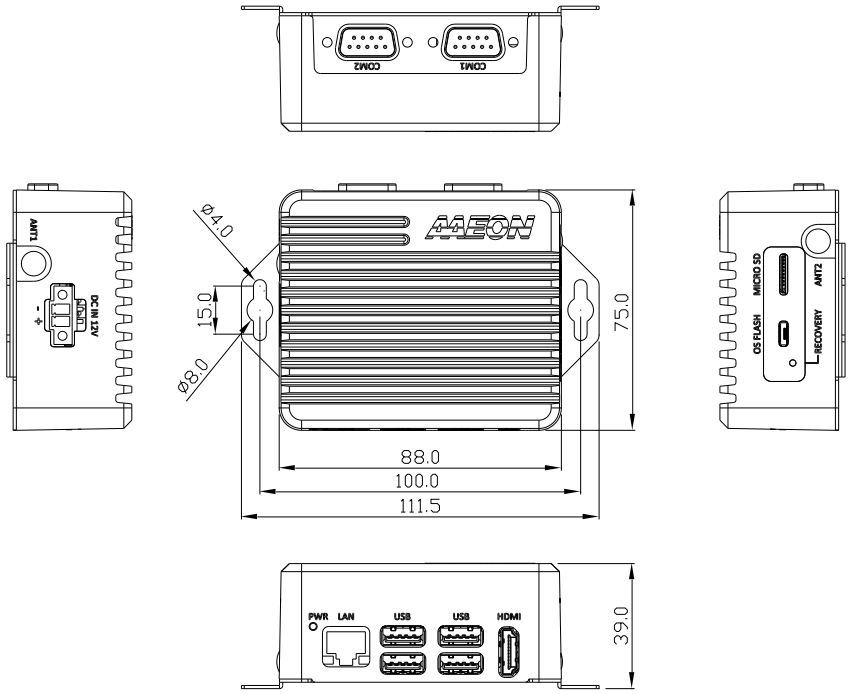

2.2 Jumpers and connectors

Component Side

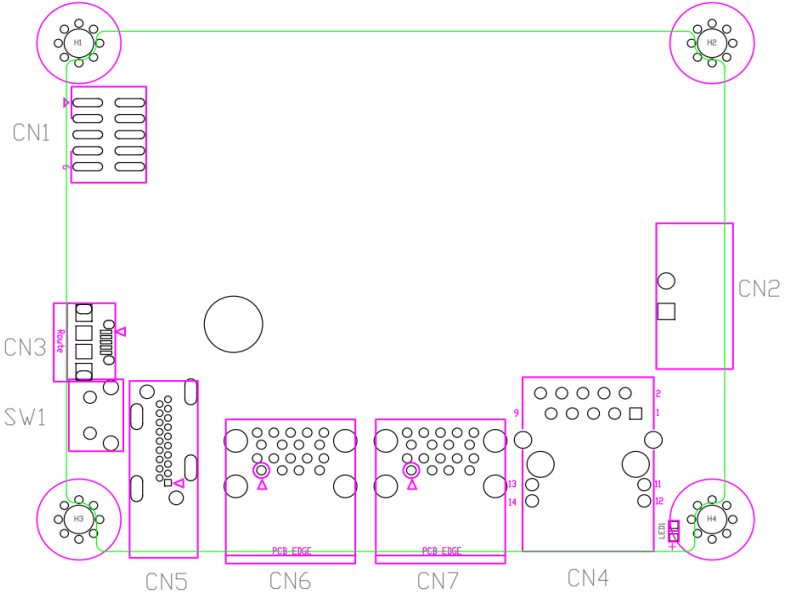

Module Side

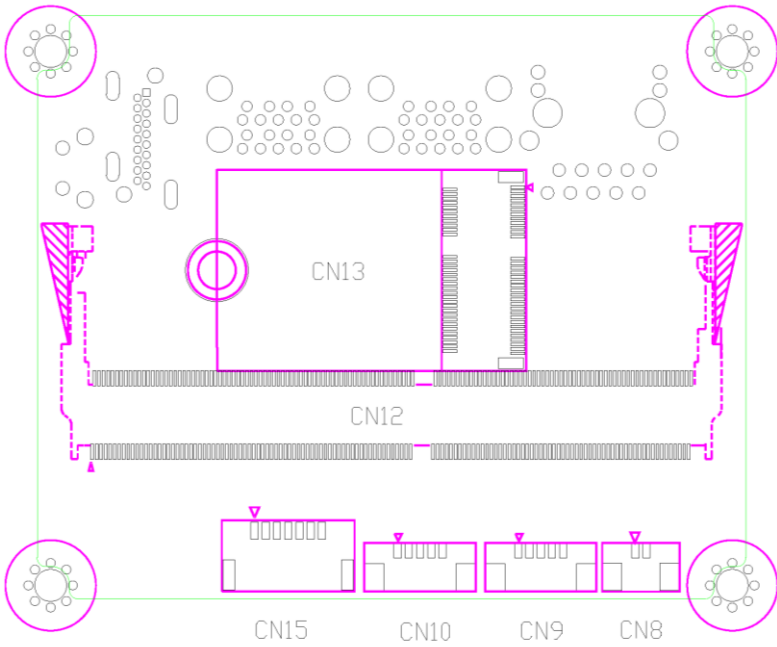

2.3 List of Jumpers

The board has a number of jumpers that allow you to configure your system to suit your application.

The table below shows the function of each of the board's jumpers

Label	Function
CN1 (Pin 7-8)	AT/ATX mode select

2.3.1 Setting Jumpers

You can configure your system to match the needs of your application by setting jumpers. A jumper is the simplest kind of electric switch. It consists of two metal pins and a small metal clip (often protected by a plastic cover) that slides over the pins to connect them. To “close” a jumper you connect the pins with the clip.

To “open” a jumper you remove the clip. Sometimes a jumper will have three pins, labeled 1, 2 and 3. In this case you would connect either pins 1 and 2 or 2 and 3.

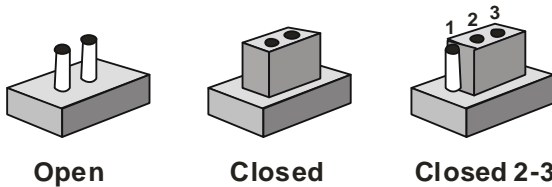

A pair of needle-nose pliers may be helpful when working with jumpers.

If you have any questions about the best hardware configuration for your application, contact your local distributor or sales representative before you make any changes.

Generally, you simply need a standard cable to make most connections.

2.3.2 AT/ATX Mode Select (CN1 Pins 7-8)

The AT/ATX Mode Select functions by connecting pins 7 and 8 of CN1. To prevent damage to the system, do not connect pins 7 and 8 to any other pin.

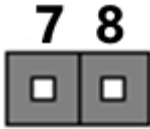

Open – AT Mode
(Default)

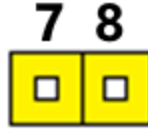

Closed – ATX Mode

CN1 pins 7-8	Function
7-8 Open	AT Power Mode (Default)
7-8 Closed	ATX Power Mode

2.4 List of Connectors

The board has a number of connectors that allow you to configure your system to suit your application.

The table below shows the function of each of the board's connectors

Label	Function
CN1	Front Panel Connector
CN2	DC Power In Connector
CN3	Micro USB for Flash image
CN4	Giga LAN Connector
CN5	HDMI Connector
CN6	Dual USB 3.2 Gen 1 Connector
CN7	Dual USB 3.2 Gen 1 Connector
CN8	RTC Connector
CN9	COM1 Connector /dev/ttyTHS1
CN10	COM2 Connector /dev/ttyTHS0
CN12	Jetson Xavier NX CPU module connector
CN13	M.2 E key
CN15	UART for Debug
SW1	Recovery switch

Note: USB 3.2 Gen 1 uses the same specifications as USB 3.0 (transfer rate 5Gbs).

2.4.1 Front Panel Connector (CN1)

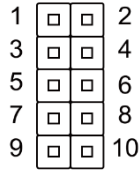

Pin	Signal	Pin	Signal
1	Button power	2	GND
3	Recovery	4	GND
5	Reset	6	GND
7	Latch set	8	Latch set
9	PWR LED	10	+5V

Note: Pin 7 and 8 are used for setting AT/ATX Power Mode. See [Chapter 2.3.2](#) for information. To prevent damage to your system, do not connect Pins 7 and 8 with any other pin.

2.4.2 DC Power In Connector (CN2)

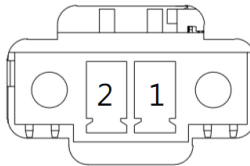

Pin	Signal	Pin	Signal
1	PWR_IN	2	GND

2.4.3 USB 2.0 Connector for Flash Image (CN3)

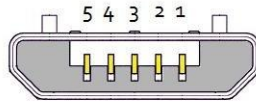

USB Micro-B

Pin	Signal	Pin	Signal
1		2	USB1-
3	USB1+	4	
5	GND		

2.4.4 LAN RJ45 Port (CN4)

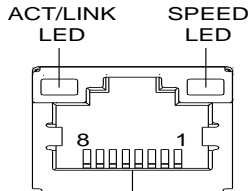

Pin	Signal	Pin	Signal
1	MDI0+	2	MDI0-
3	MDI1+	4	MDI1-
5	MDI2+	6	MDI2-
7	MDI3+	8	MDI3-

2.4.5 HDMI Connector (CN5)

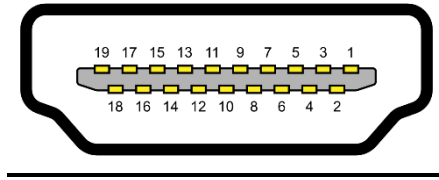

Pin	Signal	Pin	Signal
1	HDMI_DATA2_P	2	GND
3	HDMI_DATA2_N	4	HDMI_DATA1_P
5	GND	6	HDMI_DATA1_N
7	HDMI_DATA0_P	8	GND
9	HDMI_DATA0_N	10	HDMI_CLK_P
11	GND	12	HDMI_CLK_N
13	NC	14	NC
15	HDMI_SCL	16	HDMI_SDA
17	GND	18	HDMI_PWR
19	HDMI_HDP		

2.4.6 Dual USB 3.2 Gen 1 Connector (CN6/CN7)

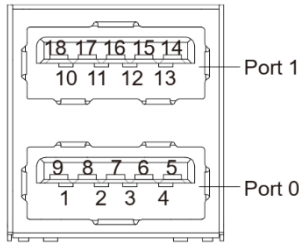

Pin	Signal	Pin	Signal
U1	VBUS_1	U10	VBUS_2
U2	(A)D-	U11	(B)D-
U3	(A)D+	U12	(B)D+
U4	GND	U13	GND
U5	(A)SSRX-	U14	(B)SSRX-
U6	(A)SSRX+	U15	(B)SSRX+
U7	GND	U16	GND
U8	(A)SSTX-	U17	(B)SSTX-
U9	(A)SSTX+	U18	(B)SSTX+

2.4.7 RTC Battery Connector (CN8)

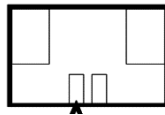

Pin	Signal	Pin	Signal
1	+3V	2	GND

2.4.8 COM Port Connector (CN9/CN10)

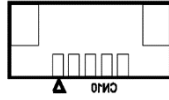

Pin	RS-232	UART (3.3V)
1	TXD	
2	RXD	
3		UART TXD
4		UART RXD
5	GND	
6		
7		
8		
9		

2.4.9 COM Port Connector (System)

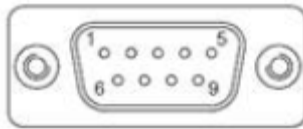

Pin	RS-232	UART (3.3V)
1		
2	RXD	
3	TXD	
4		

Pin	RS-232	UART (3.3V)
5	GND	
6		
7		UART RXD
8		UART TXD
9		

2.4.10 Jetson Xavier CPU Module Connector (CN12)

Module Signal Name	Pin #	Pin #	Module Signal Name
GND	1	2	GND
CSI F D0 P	3	4	CSI B D0 N
CSI F D0 N	5	6	CSI B D0 P
GND	7	8	GND
CSI F CLK P	9	10	RSVD
CSI F CLK N	11	12	RSVD
GND	13	14	GND
CSI F D1 P	15	16	CSI B D1 P
CSI F D1 N	17	18	CSI B D1 N
GND	19	20	GND
CSI F D0 P	21	22	CSI A D0 P
CSI F D0 N	23	24	CSI A D0 N
GND	25	26	GND
CSI F CLK P	27	28	CSI A CLK P
CSI F CLK N	29	30	CSI A CLK N
GND	31	32	GND
CSI F D1 P	33	34	CSI A D1 N
CSI F D1 N	35	36	CSI A D1 P
GND	37	38	GND
HDMI TXD0 N	39	40	CSI C D0 N
HDMI TXD0 P	41	42	CSI C D0 P
GND	43	44	GND
HDMI TXC P	45	46	CSI C CLK N
HDMI TXC N	47	48	CSI C CLK P
GND	49	50	GND
HDMI TXD1 P	51	52	CSI C D1 P
HDMI TXD1 N	53	54	CSI C D1 N
GND	55	56	GND
HDMI TXD2 N	57	58	CSI D D0 P
HDMI TXD2 P	59	60	CSI D D0 N
GND	61	62	GND
EDP TXD1 N	63	64	CSI D D1 P
EDP TXD1 P	65	66	CSI D D1 N
GND	67	68	GND
EDP TXD3 N	69	70	DSI A D1 N
EDP TXD3 P	71	72	DSI A D1 P
GND	73	74	GND
EDP TXD0 P	75	76	DSI A CLK N
EDP TXD0 N	77	78	DSI A CLK P
GND	79	80	GND
EDP TXD2 P	81	82	DSI A D0 N
EDP TXD2 N	83	84	DSI A D0 P
GND	85	86	GND
USB VBUS FNO	87	88	HDMI INT DP HPD
SPI1 MOSI	89	90	HDMI CEC
SPI1 SCK	91	92	DP HPD
SPI1 MISO	93	94	DP AUX CH0 P
SPI1 CS0	95	96	DP AUX CH0 N
SPI1 CS1	97	98	DP AUX CH1 N
UART3 TXD	99	100	DP AUX CH1 P
UART3 RTS	101	102	GND
UART3 CTS	103	104	SPI2 CS0
UART3 RXD	105	106	SPI2 MISO
GND	107	108	SPI2 SCK
USB0 DN	109	110	SPI2 MOSI
USB0 DP	111	112	SPI2 CS1
GND	113	114	CAM2 PWDN
USB1 DN	115	116	CAM2 MCLK
USB1 DP	117	118	CAM AF EN
GND	119	120	CAM1 PWDN
USB2 DN	121	122	CAM1 MCLK
USB2 DP	123	124	GPIO PH6
GND	125	126	GPS EN
NEC INT	127	128	AP WAKE NEC
GND	129	130	NEC EN
PEX RX2 N	131	132	GND

Module Signal Name	Pin #	Pin #	Module Signal Name
PEX RX2 P	133	134	PEX TX2 N
GND	135	136	PEX TX2 P
PEX RX1 N	137	138	GND
PEX RX1 P	139	140	PEX TX1 N
GND	141	142	PEX TX1 P
RSVD	143	144	GND
KEY	KEY	KEY	KEY
RSVD	145	146	GND
GND	147	148	PEX TX3 N
PEX RX3 P	149	150	PEX TX3 P
PEX RX3 N	151	152	GND
GND	153	154	PEX CLK1 N
PEX BX4 P	155	156	PEX CLK1 P
PEX BX4 N	157	158	GND
GND	159	160	PEX TX4 P
PEX RX6 N	161	162	PEX TX4 N
PEX RX6 P	163	164	GND
GND	165	166	PEX TX6 P
RSVD	167	168	PEX TX6 N
RSVD	169	170	GND
GND	171	172	RSVD
RSVD	173	174	RSVD
RSVD	175	176	GND
GND	177	178	MOD_SLEEP*
PEX WAKE	179	180	PEX LO_CLKREQ
PEX LO_RST	181	182	RSVD
RSVD	183	184	GBE MDI3 P
GEN1_I2C_SCL	185	186	GBE MDI3 N
GEN1_I2C_SDA	187	188	GBE LED1
GEN2_I2C_SCL	189	190	GBE MDI2 N
GEN2_I2C_SDA	191	192	GBE MDI2 P
DAP4_DIN	193	194	GBE LED0
DAP4_FS	195	196	GBE MDI1 N
DAP4_DOUT	197	198	GBE MDI1 P
DAP4_SCLK	199	200	GND
GND	201	202	GBE MDIO N
UART2_RTS	203	204	GBE MDIO P
UART2_CTS	205	206	LCD_BL_PWM
UART2_TXD	207	208	GPIO_PZ2(FAN_TACH)
UART2_RXD	209	210	CLK_32K_OUT
AUD_MCLK	211	212	LCD_BL_EN
CAM_I2C_SCL	213	214	FORCE_RECOVERY*
CAM_I2C_SDA	215	216	GPIO_PZ0
GND	217	218	LCD_TE
SDMMC3_DAT0	219	220	DAP3_DOUT
SDMMC3_DAT1	221	222	DAP3_DIN
SDMMC3_DAT2	223	224	DAP3_FS
SDMMC3_DAT3	225	226	DAP3_SCLK
SDMMC3_CMD	227	228	GPIO_PZ6
SDMMC3_CLK	229	230	GPIO_PZ7(FAN_PWM1)
GND	231	232	GEN3_I2C_SDA
SHUTDOWN_REQ*	233	234	GEN3_I2C_SCL
PMIC_BBAT	235	236	UART1_TXD
POWER_EN	237	238	UART1_RXD
SYS_RESET_IN*	239	240	BUTTON_PWR_ON*
GND	241	242	GND
GND	243	244	GND
GND	245	246	GND
GND	247	248	GND
GND	249	250	GND
VDD_IN	251	252	VDD_IN
VDD_IN	253	254	VDD_IN
VDD_IN	255	256	VDD_IN
VDD_IN	257	258	VDD_IN
VDD_IN	259	260	VDD_IN

2.4.11 UART Debug Port Connector (CN15)

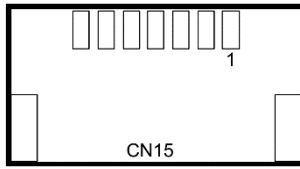

Pin	
1	3.3V
2	UART0 TXD
3	UART0 RXD
4	GND
5	I2C SCL
6	I2C SDA
7	GND

2.5 Hardware Assembly

Chassis Assembly

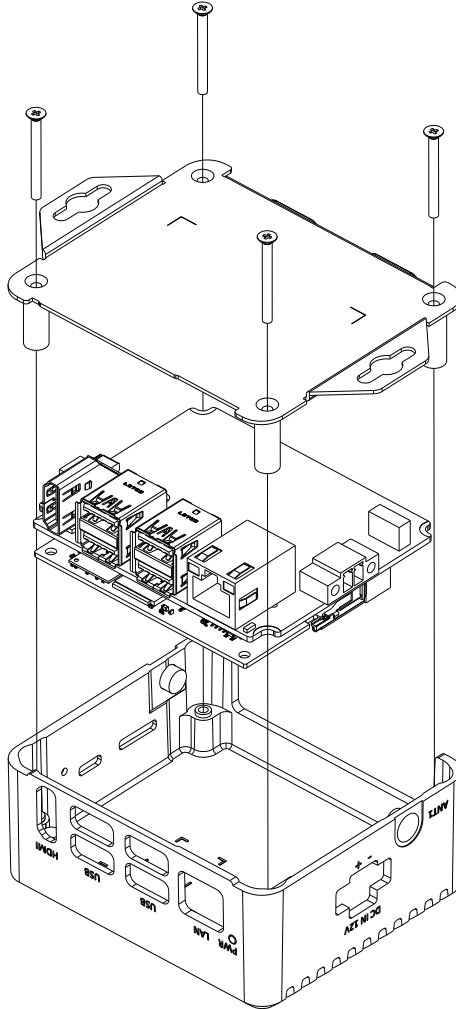

M.2 Module Installation

M.2 module attaches to the BOXER-8251AI board. NVIDIA Jetson Xavier NX module must be removed prior to installing M.2 module.

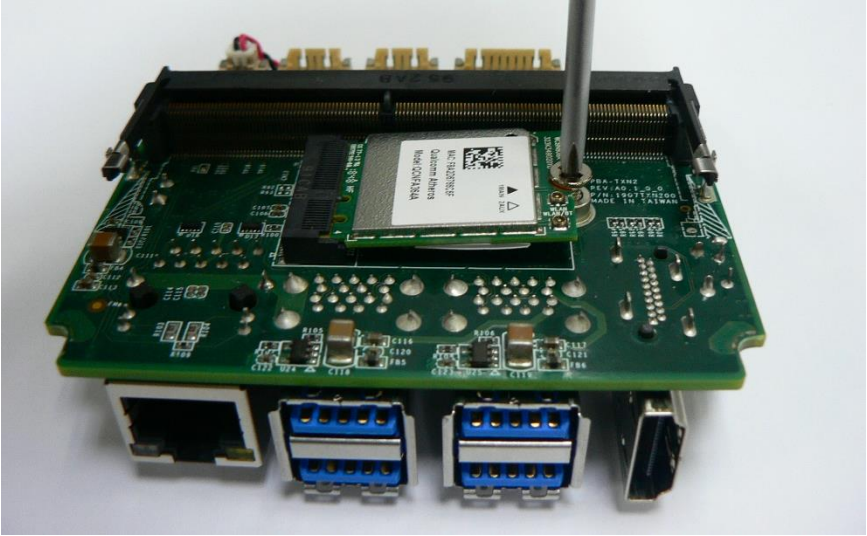

Chapter 3

OS Flash Guide

3.1 Before Installation

Before starting the process make sure your BOXER-8251AI system is turned off and the power in is disconnected. You will need a host PC running Ubuntu 16.04 or 18.04, and make sure the NVIDIA Jetson Xavier NX module is installed onto the BOXER-8251AI carrier board/ system.

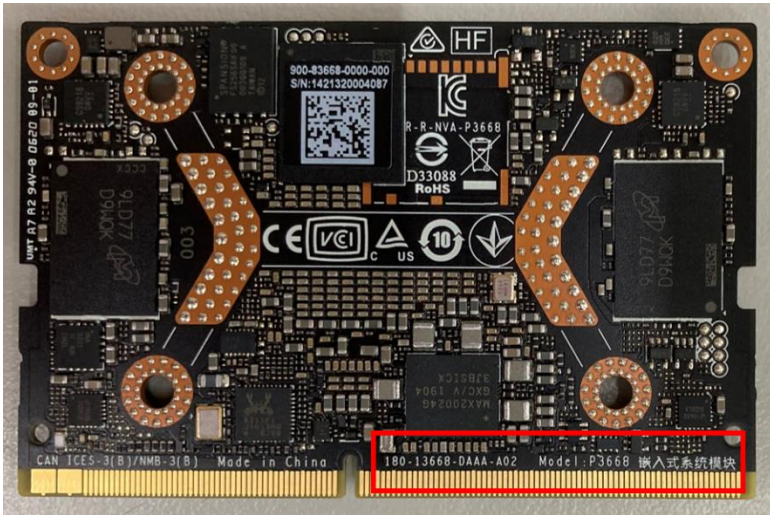

Download the compressed OS image file. The file name will follow the format of:

`ACLinux_4.9_{OS_IF}._{PLF_IF}._{PJ_IF}._{BN}.tar.gz`

For example:

`ACLinux_4.9_ACLNX49D.NV05.BOXER-8251AI.2.tar.gz`

Note: Filename may differ from this example.

- I. `{OS_IF}` is OS Information. For example, `ACLNX49D` means ACLinux 4.9, Desktop version.
- II. `{PLF_IF}` is Platform Information; e.g. `NV05`
- III. `{PJ_IF}` is Project Information; e.g. `BOXER-8251AI`
- IV. `{BN}` is Build Number; e.g. 0, 1, 2, etc.

3.2 Force USB Recovery Mode

On Host Computer, open Linux terminal and enter the following command to extract compressed OS image files (*file name may vary*):

```
$ tar -zxvf ACLinux_4.9_ACLNX49D.NV05.BOXER-8251AI.2.tar.gz
```

Next, perform the following steps to force the system to start in USB Recovery Mode:

1. Connect the Micro-USB plug on the USB cable to the Recovery Port on the BOXER-8251AI and the other end to an available USB port on the host PC.



2. Press and hold the FORCE RECOVERY button. FORCE RECOVERY button is highlighted in the following image:

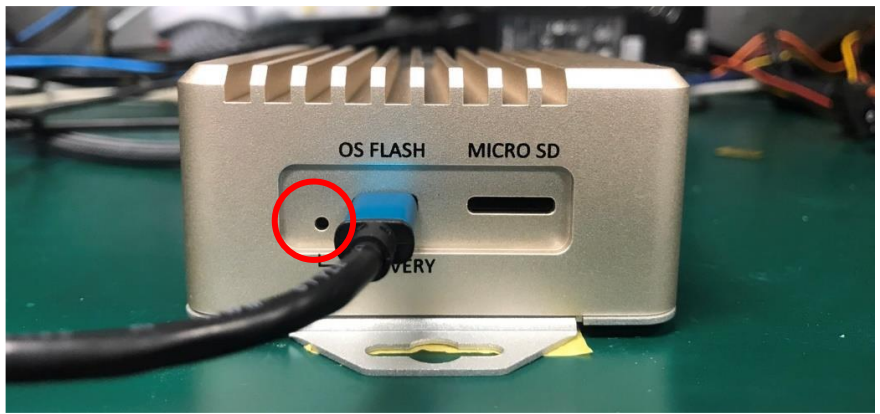

3. While holding the FORCE RECOVERY button, connect the power adapter. Continue to hold the FORCE RECOVERY button for two seconds, then release.

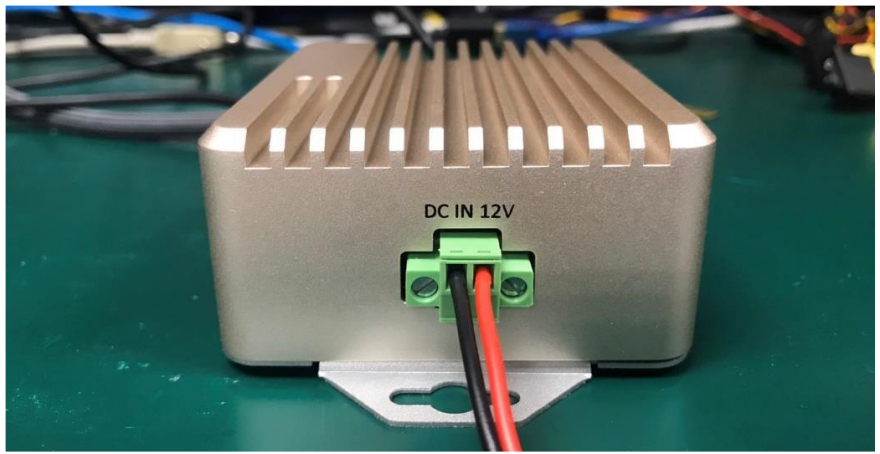

4. When device is in recovery mode, lsusb command on host PC will list a line of "0955:7e19 NVidia Corp"

Recovery mode can also be initiated with the system disassembled. Ensure the NVIDIA Jetson Xavier NX module is installed and refer to the image below to perform the steps:

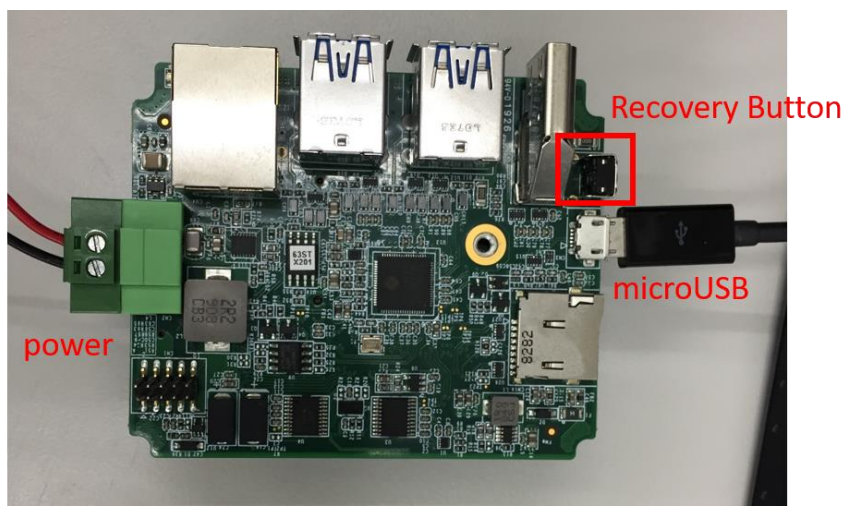

3.2 Flash Image to Board

Use the following steps to flash the OS to the BOXER-8251AI.

- 1) Open terminal on Linux host PC, then access the bootloader folder you extracted in the previous section.
- 2) Enter the following command in terminal to flash the image:

```
$ sudo ./flashall.sh
```

- 3) Wait as the image is installed. Once finished you should see the following:

```
[ 293.2436 ] Writing partition bmpm-fw-dtb with tegra194-a02-bmpm-p3668-a00_sigheader.dtb.encrypt
[ 303.9612 ] [.....] 100%
[ 303.9665 ] Writing partition bmpm-fw-dtb_b with tegra194-a02-bmpm-p3668-a00_sigheader.dtb.encrypt
[ 306.1408 ] [.....] 100%
[ 306.1458 ] Writing partition VER with qspi_bootblob_ver.txt
[ 308.3194 ] [.....] 100%
[ 308.3208 ] Writing partition VER_b with qspi_bootblob_ver.txt
[ 308.3323 ] [.....] 100%
[ 308.3342 ] Writing partition master_boot_record with mbr_1.3.bin
[ 308.3448 ] [.....] 100%
[ 308.3460 ] Writing partition APP with system.img
[ 308.3520 ] [.....] 100%
[ 1182.8634 ] Writing partition kernel with boot_sigheader.img.encrypt
[ 1182.8639 ] [.....] 100%
[ 1189.4815 ] Writing partition kernel_b with boot_sigheader.img.encrypt
[ 1189.5005 ] [.....] 100%
[ 1191.1915 ] Writing partition kernel-dtb with tegra194-p3668-all-p3509-0000_sigheader.dtb.encrypt
[ 1191.2108 ] [.....] 100%
[ 1191.4403 ] Writing partition kernel-dtb_b with tegra194-p3668-all-p3509-0000_sigheader.dtb.encrypt
[ 1191.4504 ] [.....] 100%
[ 1191.9762 ]
[ 1192.1310 ] tegradevflash_v2 --write BCT br_bct_BR.bct
[ 1192.1320 ] Bootloader version 01.00.0000
[ 1192.6810 ] Writing partition BCT with br_bct_BR.bct
[ 1192.6919 ] [.....] 100%
[ 1192.9400 ]
[ 1192.9972 ] tegradevflash_v2 --write MB1_BCT mb1_cold_boot_bct_MB1_sigheader.bct.encrypt
[ 1192.9984 ] Bootloader version 01.00.0000
[ 1193.5449 ] Writing partition MB1_BCT with mb1_cold_boot_bct_MB1_sigheader.bct.encrypt
[ 1193.5455 ] [.....] 100%
[ 1194.1843 ]
[ 1194.1856 ] tegradevflash_v2 --write MB1_BCT_b mb1_cold_boot_bct_MB1_sigheader.bct.encrypt
[ 1194.1866 ] Bootloader version 01.00.0000
[ 1194.7332 ] Writing partition MB1_BCT_b with mb1_cold_boot_bct_MB1_sigheader.bct.encrypt
[ 1194.7340 ] [.....] 100%
[ 1195.1284 ]
[ 1195.1370 ] tegradevflash_v2 --write MEM_BCT mem_coldboot_sigheader.bct.encrypt
[ 1195.1379 ] Bootloader version 01.00.0000
[ 1195.6850 ] Writing partition MEM_BCT with mem_coldboot_sigheader.bct.encrypt
[ 1195.6855 ] [.....] 100%
[ 1198.2719 ]
[ 1198.2730 ] tegradevflash_v2 --write MEM_BCT_b mem_coldboot_sigheader.bct.encrypt
[ 1198.2738 ] Bootloader version 01.00.0000
[ 1198.8211 ] Writing partition MEM_BCT_b with mem_coldboot_sigheader.bct.encrypt
[ 1198.8217 ] [.....] 100%
[ 1201.3157 ]
[ 1201.3158 ] Flashing completed

[ 1201.3160 ] Coldbooting the device
[ 1201.5699 ] tegrarcM_v2 --lsm2
[ 1202.8176 ]
[ 1202.8199 ] tegradevflash_v2 --reboot coldboot
[ 1202.8221 ] Bootloader version 01.00.0000
[ 1203.3858 ]
*** The target t186ref has been flashed successfully. ***
Reset the board to boot from internal eMMC.
```